

pco.edge 3.1

scientific CMOS camera

high resolution

2048 x 1536 pixel

low noise

1.1 electrons



global
shutter

USB 3.0

small
form factor

high dynamic range

27 000:1

high speed

50 fps

high quantum efficiency

> 60 %

features

Selectable rolling shutter operation modes of pco.edge cameras.

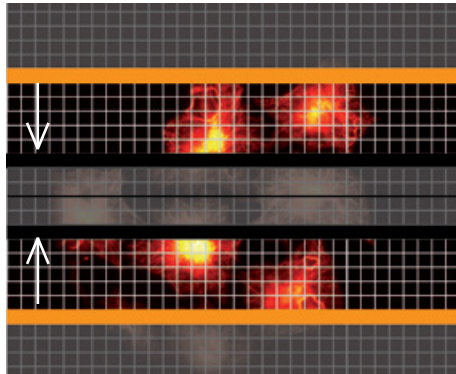

dual outside in

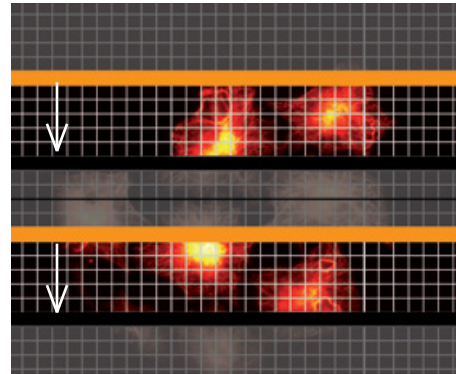

dual top down

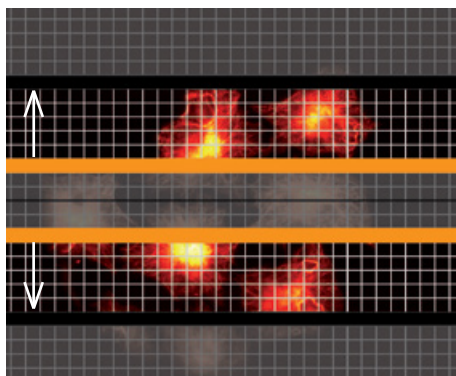

dual inside out

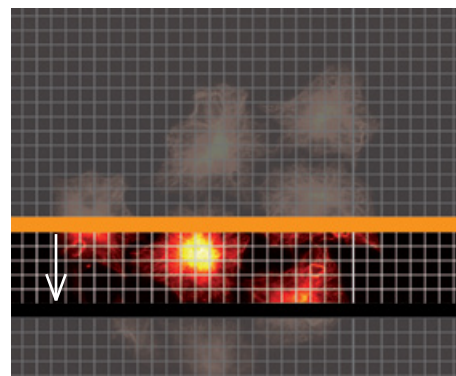

single top down

rolling shutter readout modes – optimized for synchronization of microscopes and scanning applications

All pco.edge sCMOS cameras from the beginning feature a variety of precise synchronization modes, which are optimized for advanced microscopy imaging and scanning. The flexible frame and line triggers with very low latency in combination with the free selectable readout modes can easily be combined to cover every modern microscopy situation to name a few:

- lightsheet microscopy
- selective plane imaging microscopy (SPIM)
- structured illumination microscopy
- localizations microscopy (GSD, PALM, STORM, dSTORM)
- spinning disk confocal microscopy
- RESOLFT

For example, one mode is used in a lightsheet or SPIM application, the lower right rolling shutter operational mode “single top down” operation is convenient to properly synchronize the camera exposure with the scanner. On the other hand, if speed is required and a flash like exposure is applied the upper left mode “dual outside in” is used for localization microscopy techniques like GSD, PALM or STORM.

features

superior image quality

The new pco.edge camera (with scientific CMOS image sensor) features outstanding low read out noise of 1.1 electrons (e^-) med. Even at maximum speed of 50 frames/s at full resolution of 2048 x 1536 pixel the noise is 1.1 e^- med. Moreover the pco.edge provides an excellent homogeneous pixel response to light (PRNU, photo response non-uniformity) and an excellent homogeneous dark signal pixel behaviour (DSNU, dark signal non-uniformity), which is achieved by a sophisticated electronic circuit technology and firmware algorithms. The lower figure shows a comparison of a scientific grade CCD and the new pco.sCMOS image sensor under similar weak illumination conditions. This demonstrates the superiority of pco.sCMOS over CCD with regards to read out noise and dynamic, without any smear (the vertical lines in the CCD image).

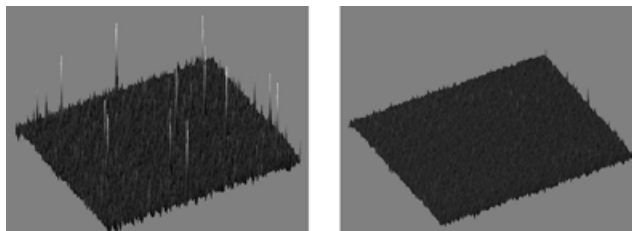

Dark image comparison with the measured distribution of “hot blinking” pixels at 5°C of the image sensor. The left image gives a 3D view with the sophisticated “blinker filter” algorithm off and the right image shows the result with the filter switched on.

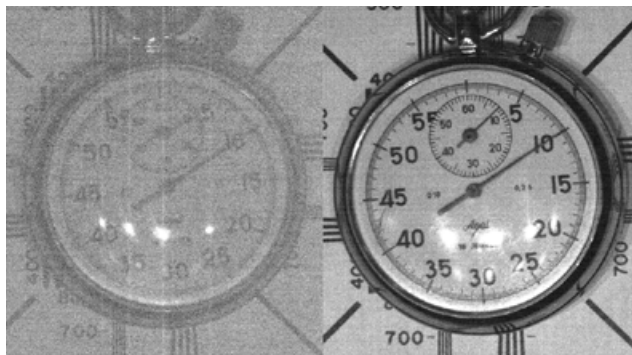

The left image was recorded by a scientific CCD camera while the right image was recorded by a pco.edge under identical conditions.

flexibility and free of latency

User selectable choice of rolling or global shutter mode for exposure provides flexibility for a wide range of applications. The advantages of rolling shutter are high frame rates and low read out noise whereas global shutter provides snapshot images for fast moving objects. Due to realtime transmission of the image data to the PC, there is no latency between recording and access or storage of the data.

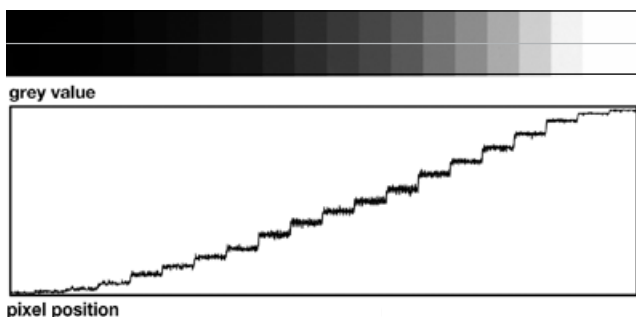

The top image shows an extract of a typical pco.edge recording of a grey scale with a 1 : 10 000 dynamic in 20 steps. The bottom image is a plot of the grey values profile along the centered line through the top image (with gamma 2.2).

27 000:1 dynamic range

Due to the excellent low noise and the high fullwell capacity of the sCMOS image sensor an intra scene dynamic range of better than 27 000 : 1 is achieved. A unique architecture of dual column level amplifiers and dual 11 bit ADCs is designed to maximize dynamic range and to minimize read out noise simultaneously. Both ADC values are analyzed and merged into one high dynamic 16 bit value.

technical data USB 3.0

image sensor

type of sensor	scientific CMOS (sCMOS)
image sensor	based on CIS2521
resolution (h x v)	2048 x 1536 pixel
pixel size (h x v)	6.5 μm x 6.5 μm
sensor format / diagonal	13.3 mm x 10.0 mm / 16.6 mm
shutter modes	rolling shutter (RS) with free selectable readout modes, global/snapshot shutter (GS), global reset - rolling readout (GR)
MTF	76.9 lp/mm (theoretical)
fullwell capacity (typ.)	30 000 e ⁻
readout noise ¹	1.1 _{med} / 1.5 _{rms} e ⁻ @RS/GR ² 2.7 _{med} / 2.9 _{rms} e ⁻ @GS
dynamic range (typ.)	27 000 : 1 (88.6 dB)
quantum efficiency	> 60 % @ peak
spectral range	370 nm .. 1100 nm
dark current (typ.)	< 0.5 e ⁻ /pixel/s RS/GR @ 5 °C < 0.8 e ⁻ /pixel/s GS @ 5 °C
DSNU	< 0.3 e ⁻ rms RS/GR < 2.0 e ⁻ rms GS
PRNU	< 0.2 %
anti blooming factor	> 10 000

frame rate table³

typical examples	GS	RS
2048 x 1536	50 fps	50 fps
1920 x 1080	72 fps	74 fps
1280 x 1024	75 fps	77 fps
640 x 480	160 fps	164 fps

camera

frame rate	50 fps @ 2048 x 1536 pixel
exposure / shutter time	500 μs .. 2 s RS 20 μs .. 100ms GS 30 μs .. 2 s GR
dynamic range A/D ⁴	16 bit
A/D conversion factor	0.46 e ⁻ /count
pixel scan rate	204.0 MHz GS 105.0 MHz RS/GR
pixel data rate	408.0 Mpixel/s GS 210.0 Mpixel/s RS/GR
binning horizontal	x1, x2, x4
binning vertical	x1, x2, x4
region of interest (ROI)	horizontal: steps of 4 pixels vertical: steps of 1 pixel
non-linearity	< 0.6 %
cooling method	+5 °C stabilized, peltier with forced air (fan) (up to 27°C ambient)
trigger input signals	frame trigger, programmable input (SMA connectors)
trigger output signals	exposure, busy, line, programmable output (SMA connectors)
data interface	USB 3.0
time stamp	in image (1 μs resolution)

general

power supply	12 .. 24 VDC (+/- 10 %)
power consumption	21 W max. (typ. 12 W @ 20 °C)
weight	900 g
operating temperature	+ 10 °C .. + 40 °C
operating humidity range	10 % .. 80 % (non-condensing)
storage temperature range	- 10 °C .. + 60 °C
optical interface	F-mount & C-mount
CE / FCC certified	yes

¹ The readout noise values are given as median (med) and root mean square (rms) values, due to the different noise models, which can be used for evaluation.

² Raw data without filtering.

³ Max. fps with centered ROI.

⁴ The high dynamic signal is simultaneously converted at high and low gain by two 11 bit A/D converters and the two 11 bit values are sophisticatedly merged into one 16 bit value.



technical data

quantum efficiency

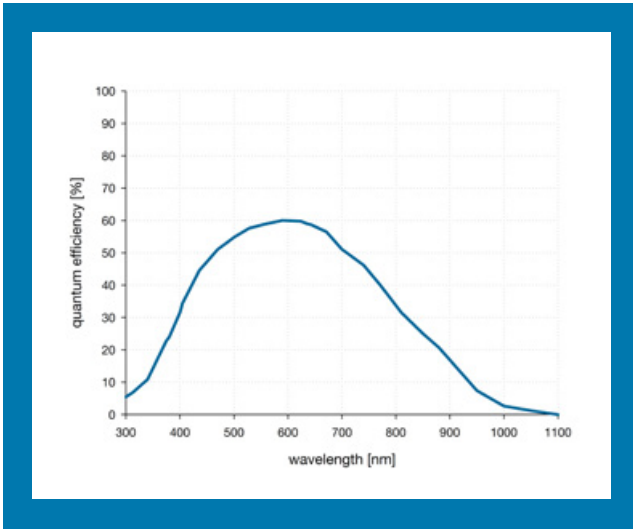

camera views



dimensions

F-mount and C-mount lens changeable adapter.

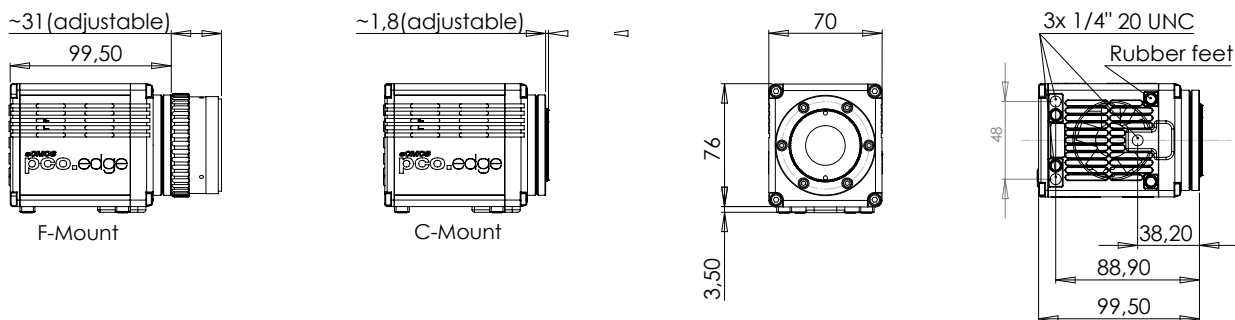

All dimensions are given in millimeter.

technical data

software

For camera control, image acquisition and archiving of images in various file formats PCO provides the software application Camware (Windows 7, 8 and later).

A camera SDK (software development kit) including a 32 / 64 bit dynamic link library for user customization and integration on PC platforms is available for free.

For camera interface drivers and a list of supported third party software please visit www.pco.de.

third party integrations

software drivers



applications

life science

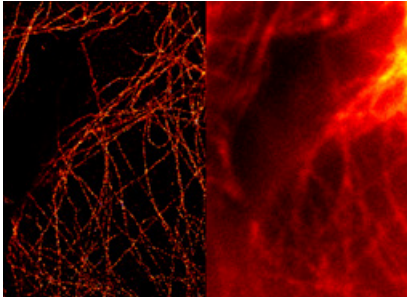

A widefield (right) and a GSDIM super-resolution (left) microscopy image of tubulin fibers obtained with a pco.edge, courtesy of Leica Microsystems, Germany

physical science

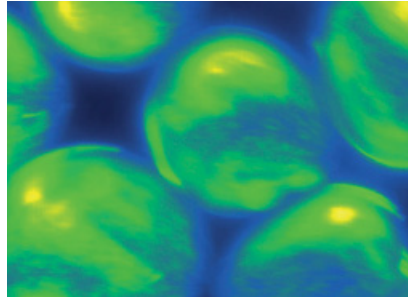

A single image of fluorescence labeled protein networks in water drops in an oil phase, which moved fast. One pixel corresponds to 0.1625 μm in reality, courtesy of Prof. Dr. Sarah Köster, Institute for X-Ray Physics, Göttingen, Germany

life science

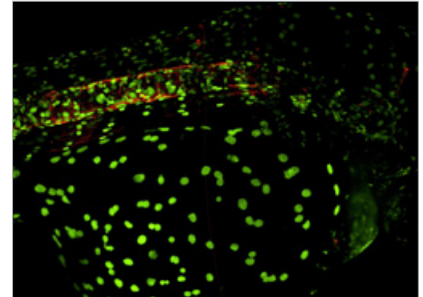

Zebrafish with two fluorescent labels, collected with a VisiScope Confocal based on the Yokogawa CSU-W1 wide head and a pco.edge camera, courtesy of Visitron Systems GmbH, Germany

life science

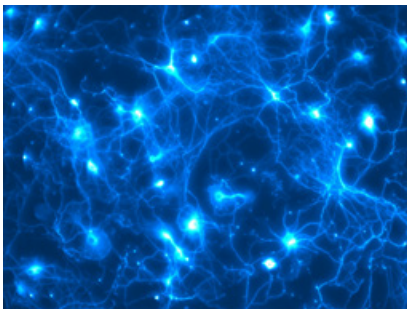

Neuronal network marked with a fluorophore (false color rendering) and recorded with a pco.edge.

life science

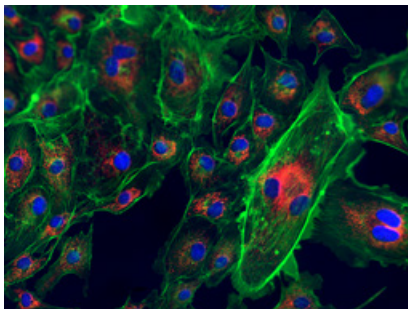

Extract of a fluorescent slide which was scanned by a pco.edge camera in a Panoramic 250 Flash scanner for digital pathology, courtesy of 3DHitech, Hungary

life science

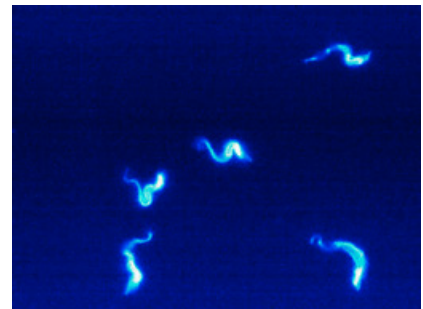

An image of a sequence, which was recorded with a pco.edge at 400 frame/s. The maximum signal was about 100 photons, courtesy of Prof. Engstler, University of Würzburg, Germany

application areas

- Widefield microscopy ■ Fluorescent microscopy ■ Digital pathology ■ PALM ■ STORM ■ GSDIM
- dSTORM ■ Superresolution microscopy ■ Lightsheet microscopy ■ Selective plane imaging microscopy (SPIM) ■ Calcium imaging ■ FRET ■ FRAP ■ 3D structured illumination microscopy ■ High speed bright field ratio imaging ■ High throughput screening ■ High content screening ■ Biochip reading ■ TIRF ■ TIRF microscopy / waveguides ■ Spinning disk confocal microscopy ■ Live cell microscopy ■ 3D metrology ■ TV / broadcasting ■ Ophthalmology ■ Electro physiology ■ Lucky astronomy ■ Photovoltaic inspection

europa

PCO AG
Donaupark 11
93309 Kelheim, Germany

+49 9441 2005 50
info@pco.de
pco.de

america

PCO-TECH Inc.
6930 Metroplex Drive
Romulus, Michigan 48174, USA

+1 248 276 8820
info@pco-tech.com
pco-tech.com

asia

PCO Imaging Asia Pte.
3 Temasek Ave
Centennial Tower, Level 34
Singapore, 039190

+65 6549 7054
info@pco-imaging.com
pco-imaging.com

china

Suzhou PCO Imaging
Technology Co., LTD
Suzhou (Jiangsu),
P.R. China

+86 512 67634
info@pco.cn
pco.cn